

Schématisation et circuits électriques

Jeu de Dominos

Auteurs : Stéphane BOIS (Académie de Grenoble) stephanebois03@yahoo.fr
Raphaëlle DARNE (Académie de Grenoble)

Document sous licence libre CC-BY-NC-SA
<http://creativecommons.org/licenses/by-nc-sa/2.0/fr/>

Voici six jeux de "Dominos" de difficulté croissante pour faire travailler les élèves sur le passage du montage électrique au schéma normalisé et réciproquement. Les dipôles sont ceux qui peuvent être rencontrés en classe de 5e (pile, générateur, lampe, interrupteur, résistance, moteur, diode et DEL).

Il est recommandé d'imprimer les dominos sur du papier cartonné, ou mieux encore, d'imprimer sur papier normal mais de plastifier les tirages avant de massicoter entre les cartes.

Les jeux sont conçus à la base pour une utilisation linéaire (une seule carte convient à la suite d'une autre) et ils "bouclent", c'est à dire que la première carte est associée à la dernière et l'ensemble forme un rectangle qui tient sur une table.

Le jeu violet est conçu avec seulement des dipôles en série et peut être utilisé sans connaissance du sens du courant et des dipôles polarisés mais après avoir vu l'interrupteur. Le jeu jaune également mais contient en plus des dérivations. Les autres utilisent les diodes et DEL passantes et bloquées.

Correction des six jeux :

Violet : A1 A15 A4 A5 A6 A12 A16 A9 A8 A10 A11 A7 A2 A13 A14 A3

Jaune : A1 A10 A4 A8 A3 A16 A12 A6 A7 A15 A11 A5 A2 A13 A14 A9

Vert : A1 A11 A7 A9 A2 A16 A12 A6 A4 A13 A10 A5 A3 A15 A14 A8

Bleu : A1 A6 A13 A2 A15 A9 A7 A5 A11 A3 A12 A4 A10 A16 A14 A8

Orange : A1 A5 A13 A9 A4 A10 A16 A11 A14 A12 A2 A6 A3 A8 A7 A15

Rouge : A1 A2 A13 A4 A9 A12 A11 A16 A14 A15 A5 A7 A3 A8 A6 A10

A1

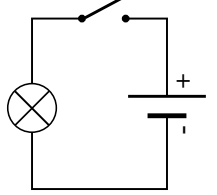
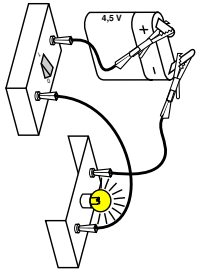

A6

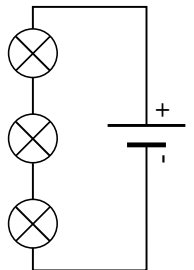
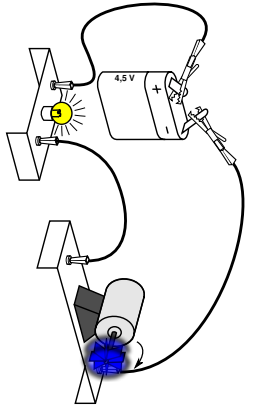

A15

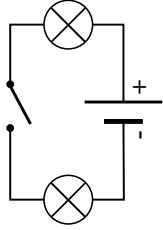
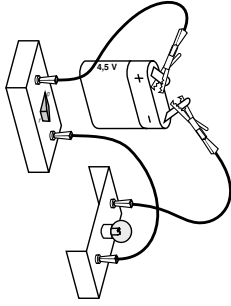

A12

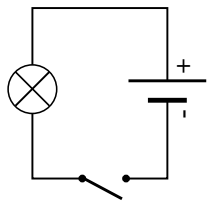
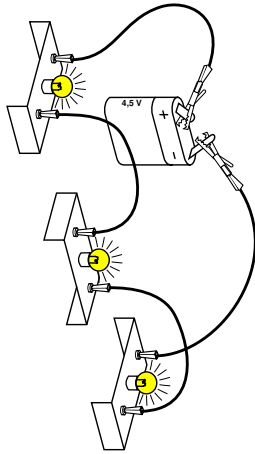

A4

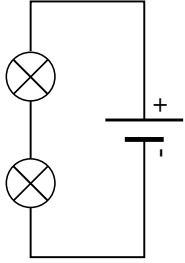
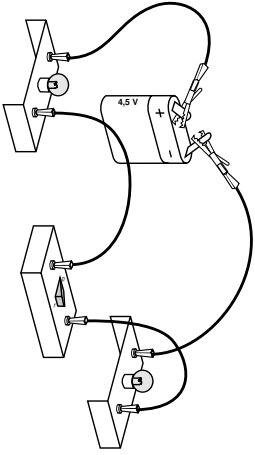

A16

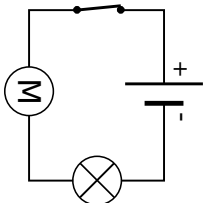
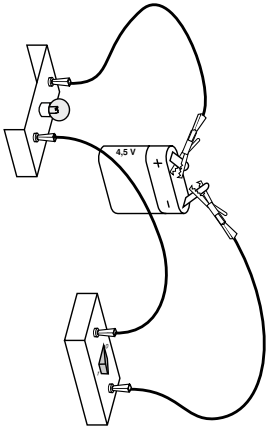

A5

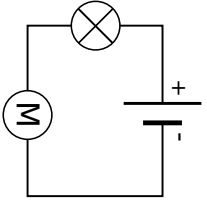
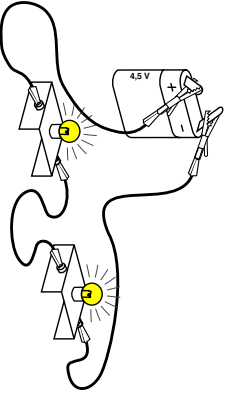

A9

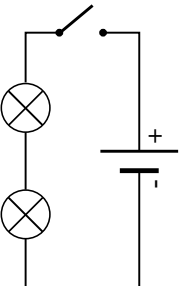
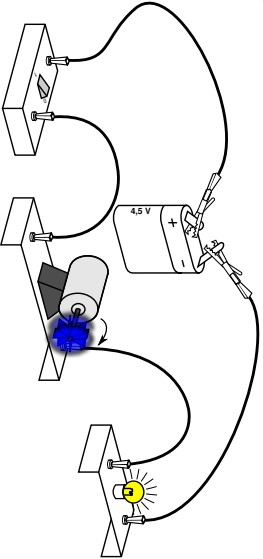

A8

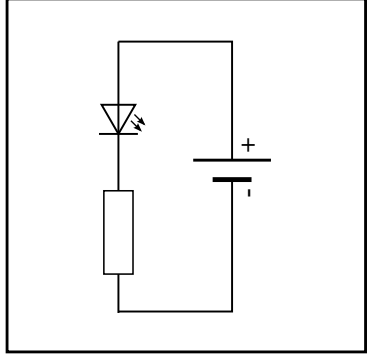
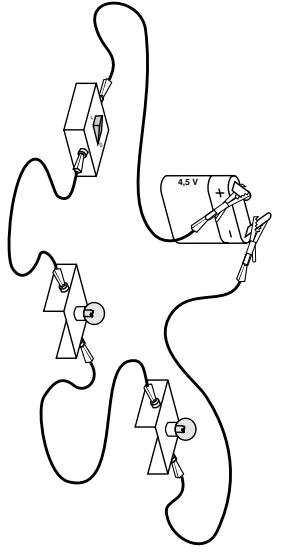

A10

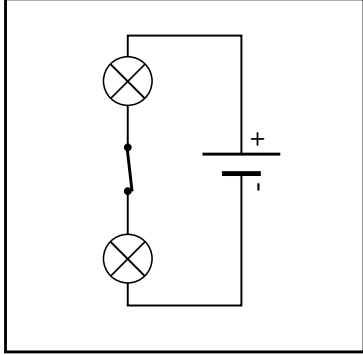
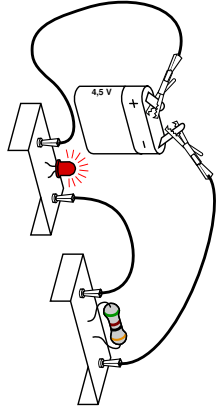

A11

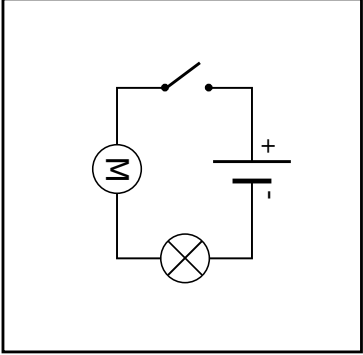
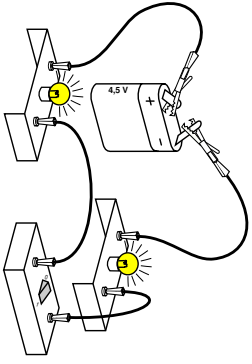

A7

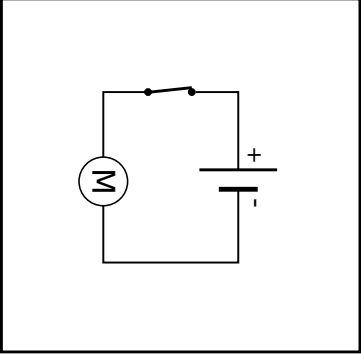
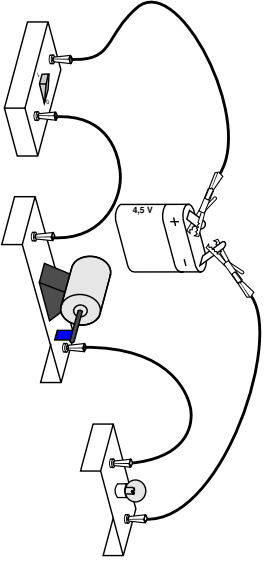

A2

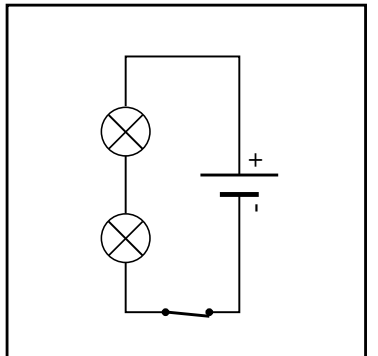
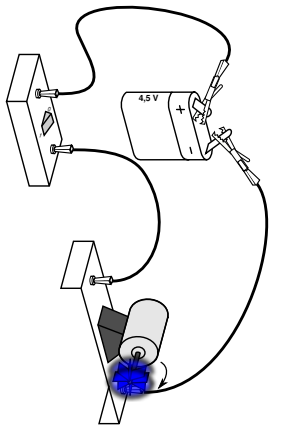

A13

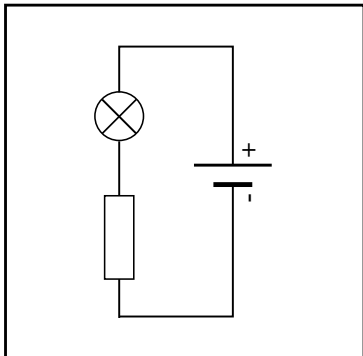
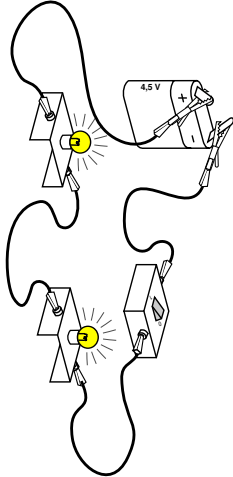

A14

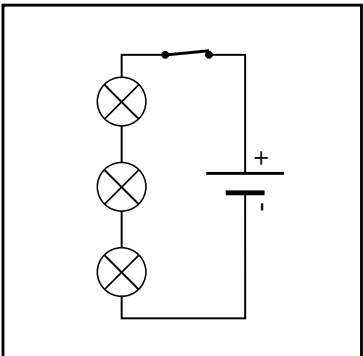
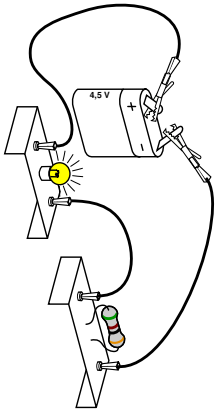

A3

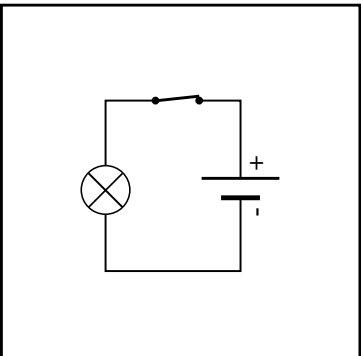
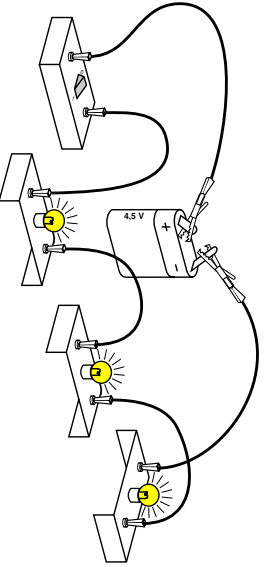

A1

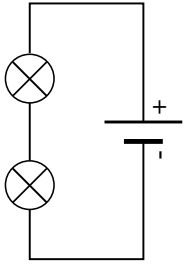
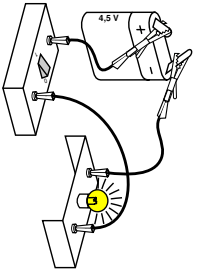

A3

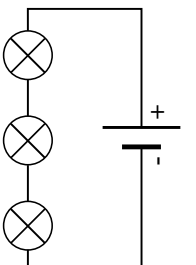
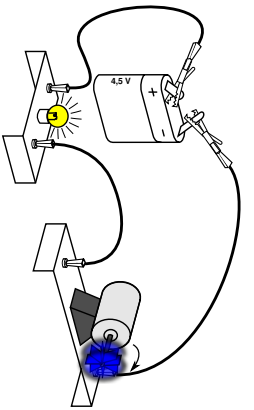

A10

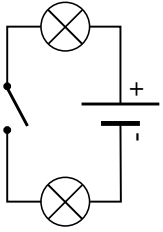
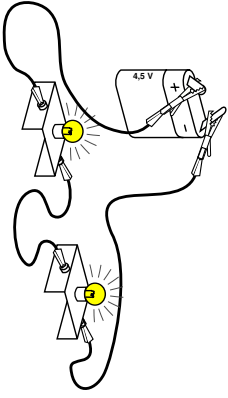

A16

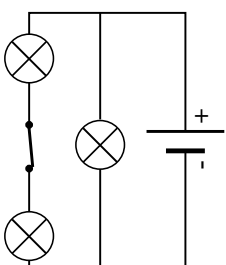
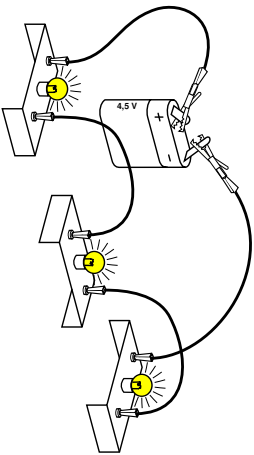

A4

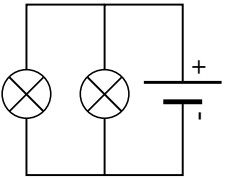
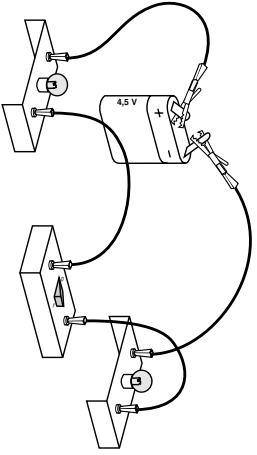

A12

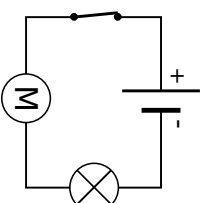
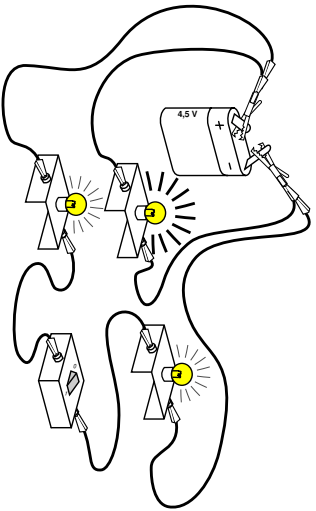

A8

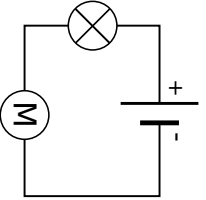
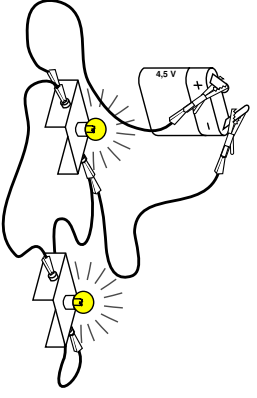

A6

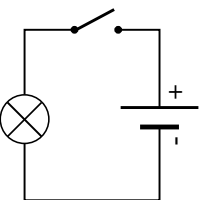
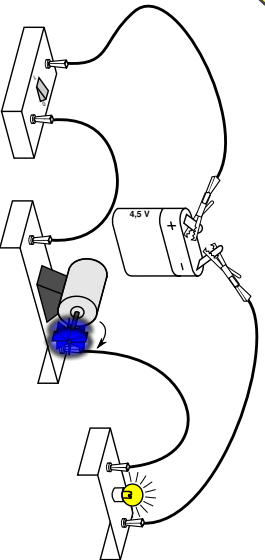

A7

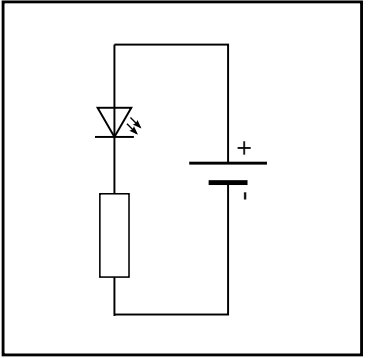
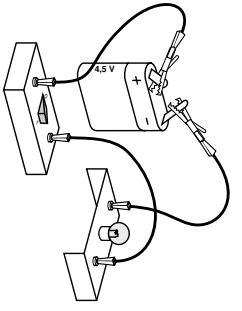

A2

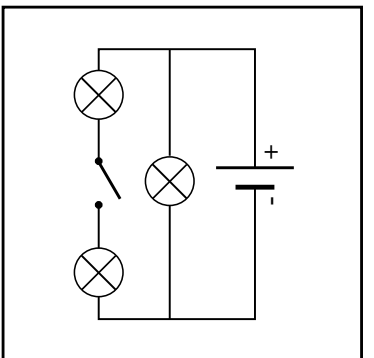
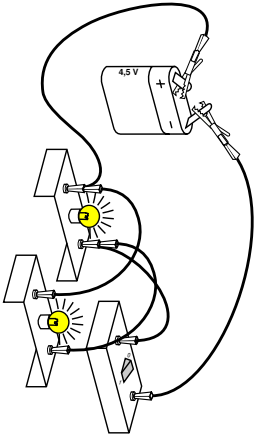

A15

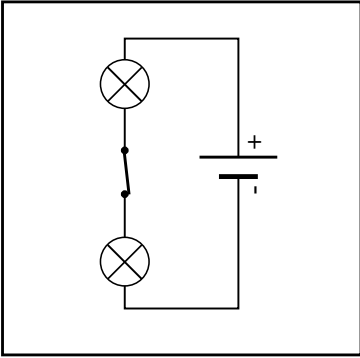
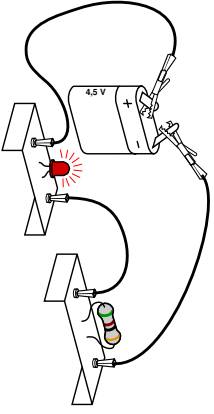

A13

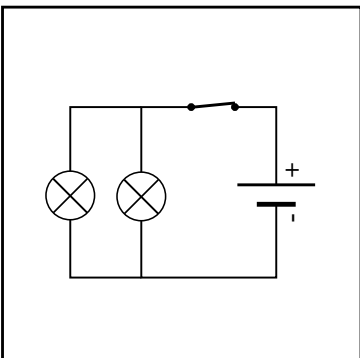
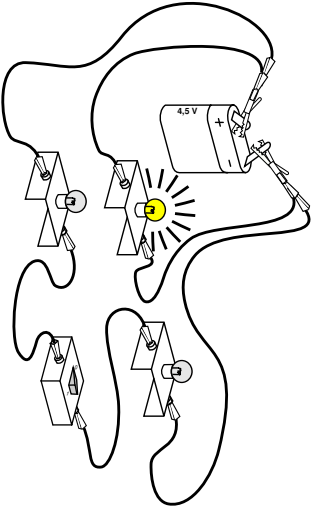

A11

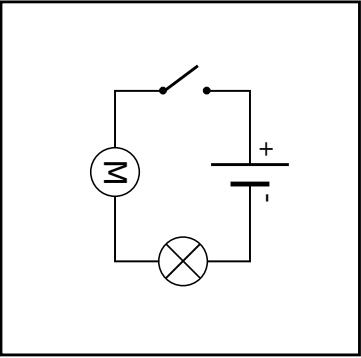
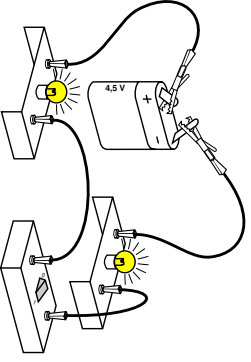

A14

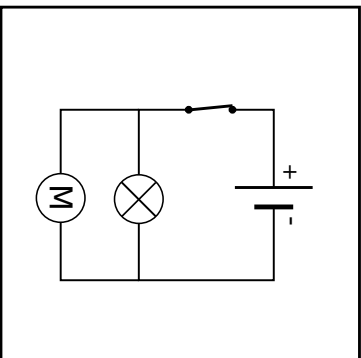
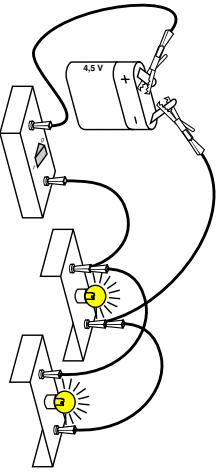

A5

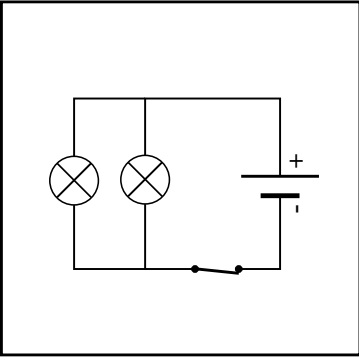
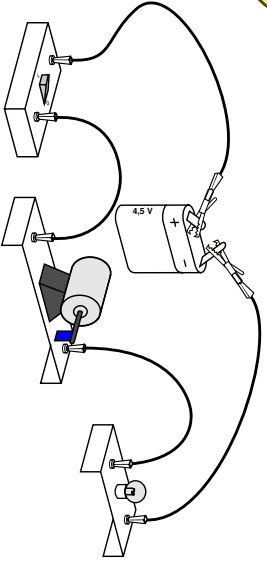

A9

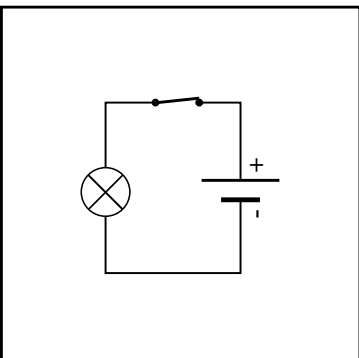
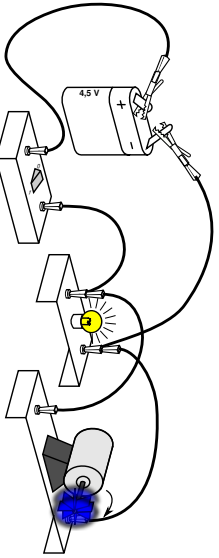

A1

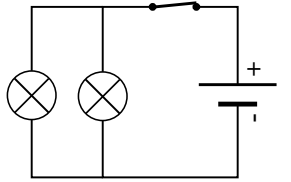
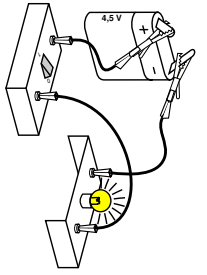

A2

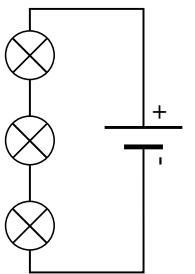
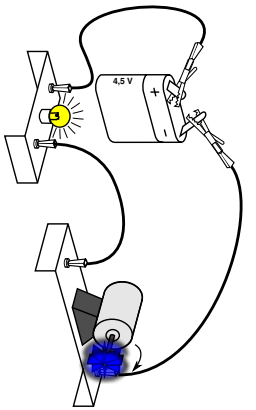

A11

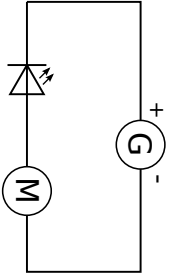
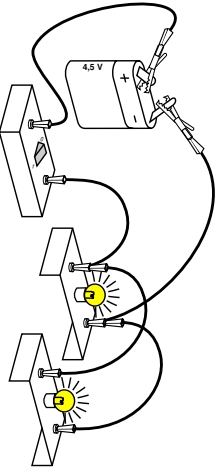

A16

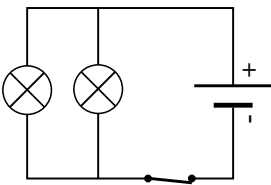
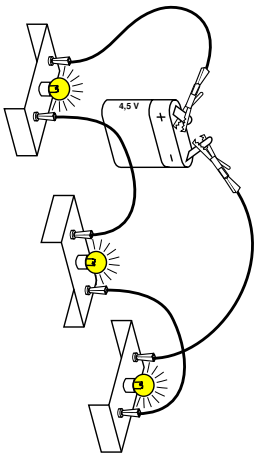

A7

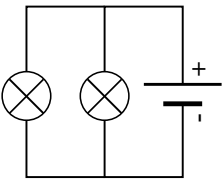
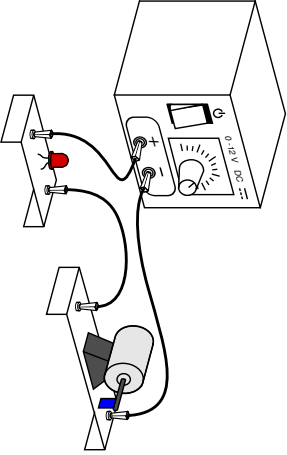

A12

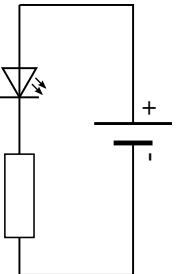
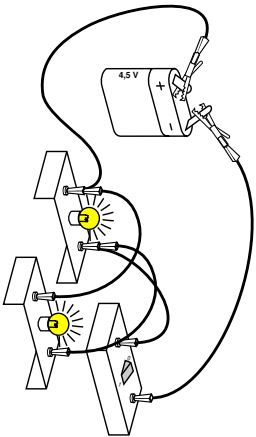

A9

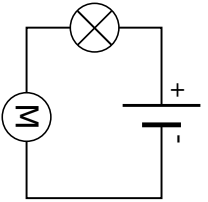
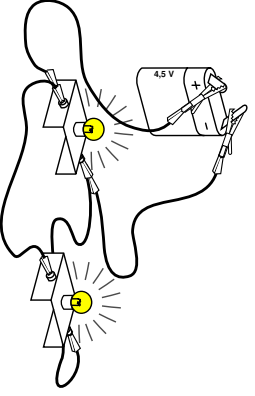

A6

